

# SP8CE CAPSULE

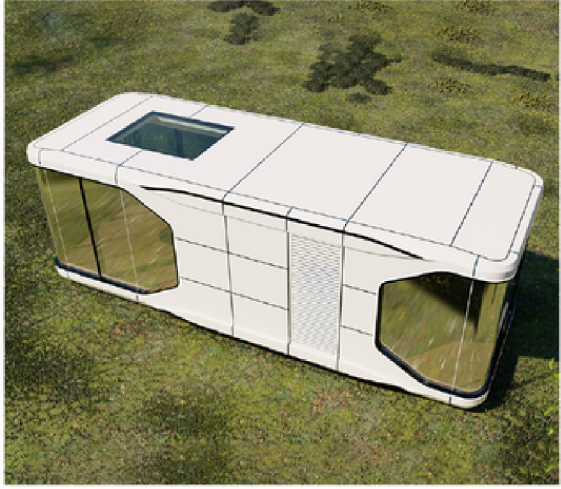

SP81

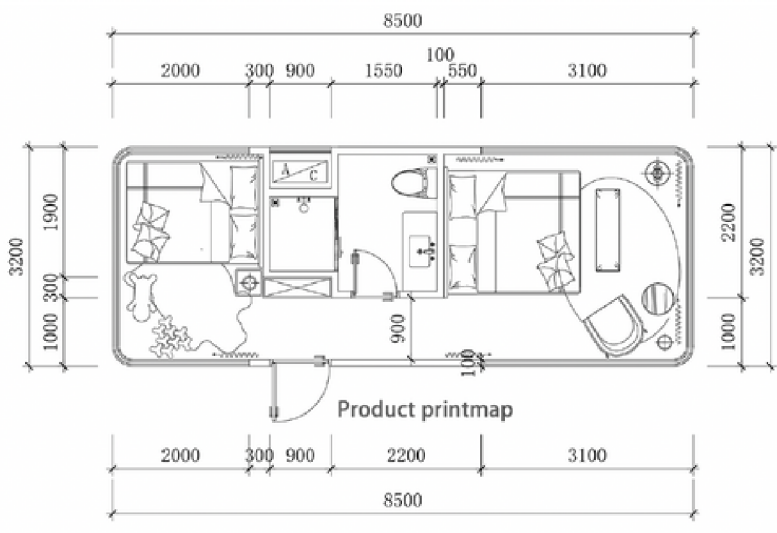

**OMA Global Pte Ltd**  
1 Scotts Road #24-05  
Singapore 228208  
dan@omastay.com

Mobile//Whatsapp +65 8284 6788



# SP8CE CAPSULE



SP81B

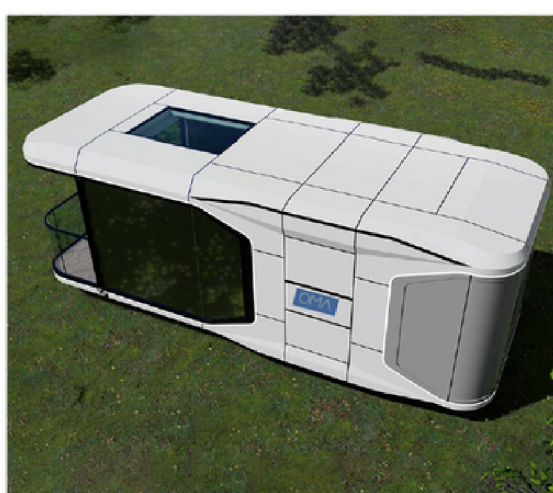
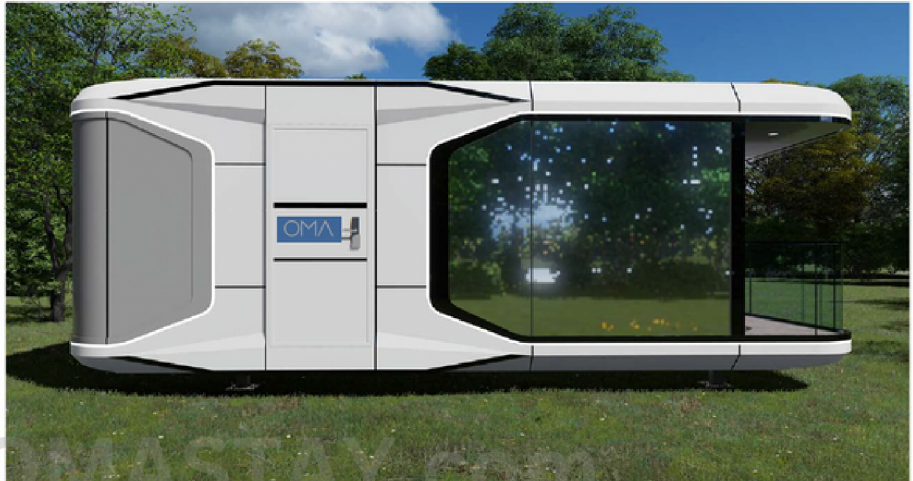
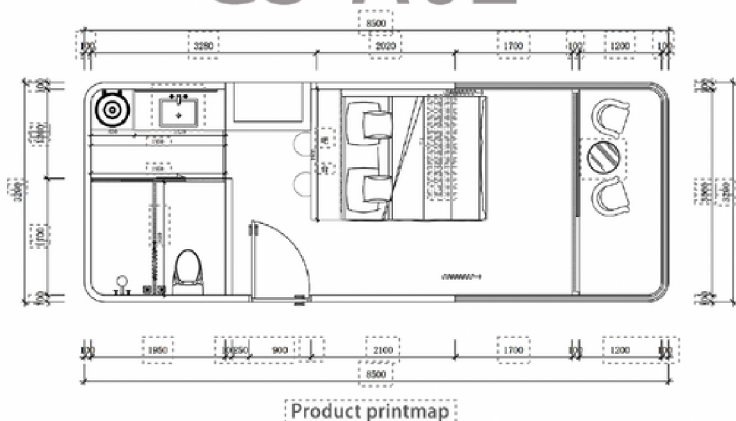
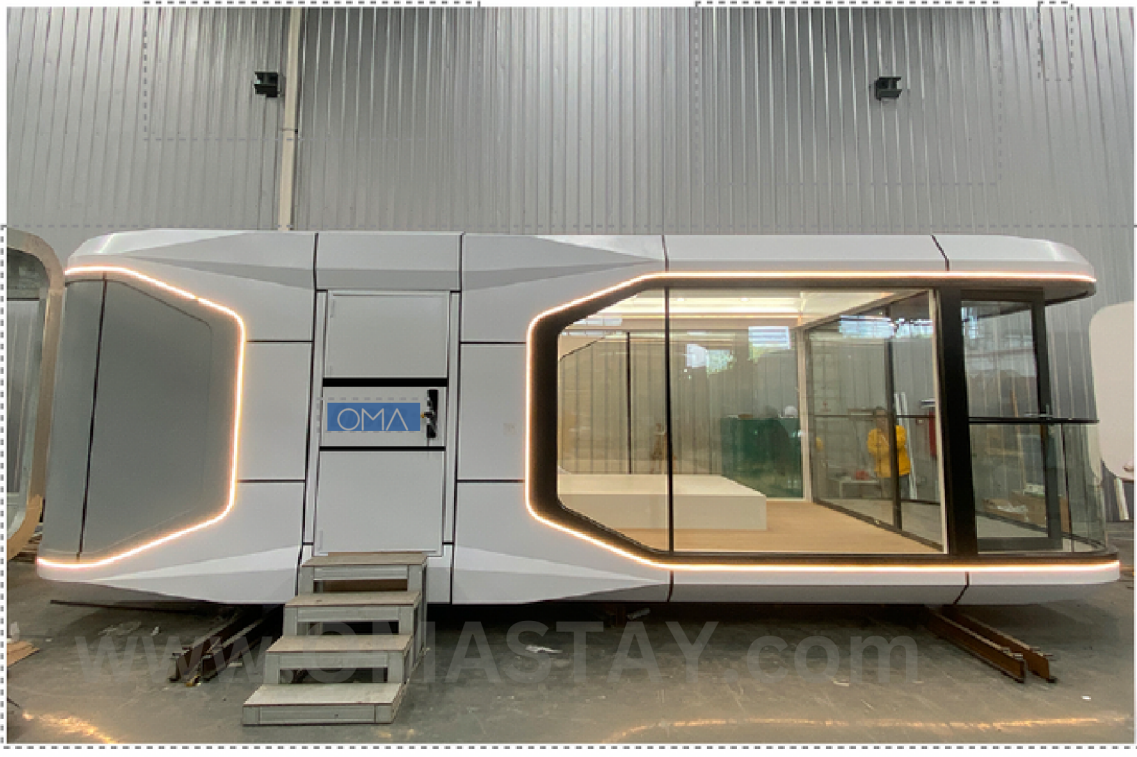

**OMA Global Pte Ltd**  
1 Scotts Road #24-05  
Singapore 228208  
dan@omastay.com

Mobile//Whatsapp +65 8284 6788



# SP8CE CAPSULE



SP82

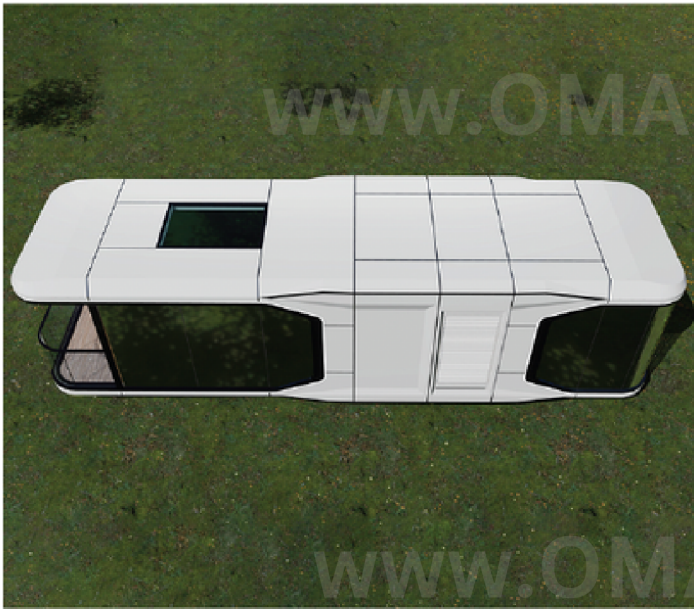
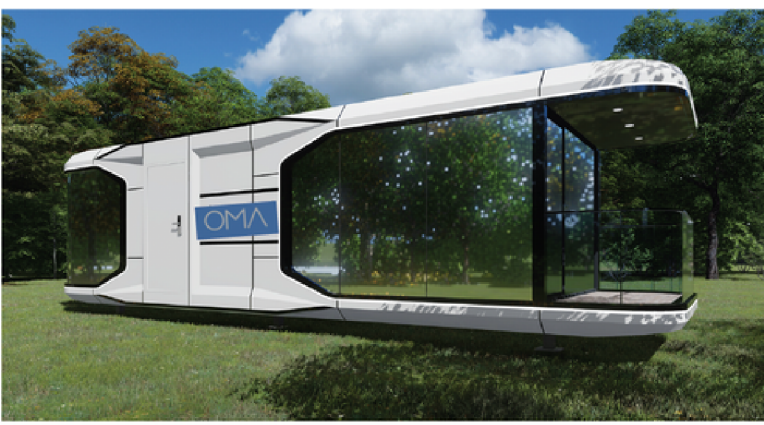
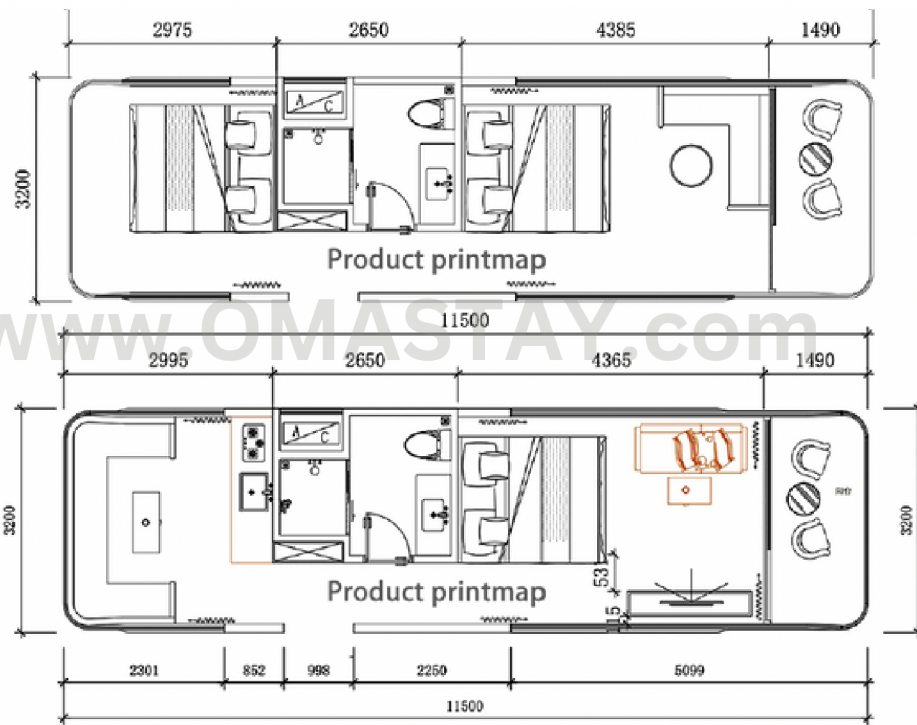
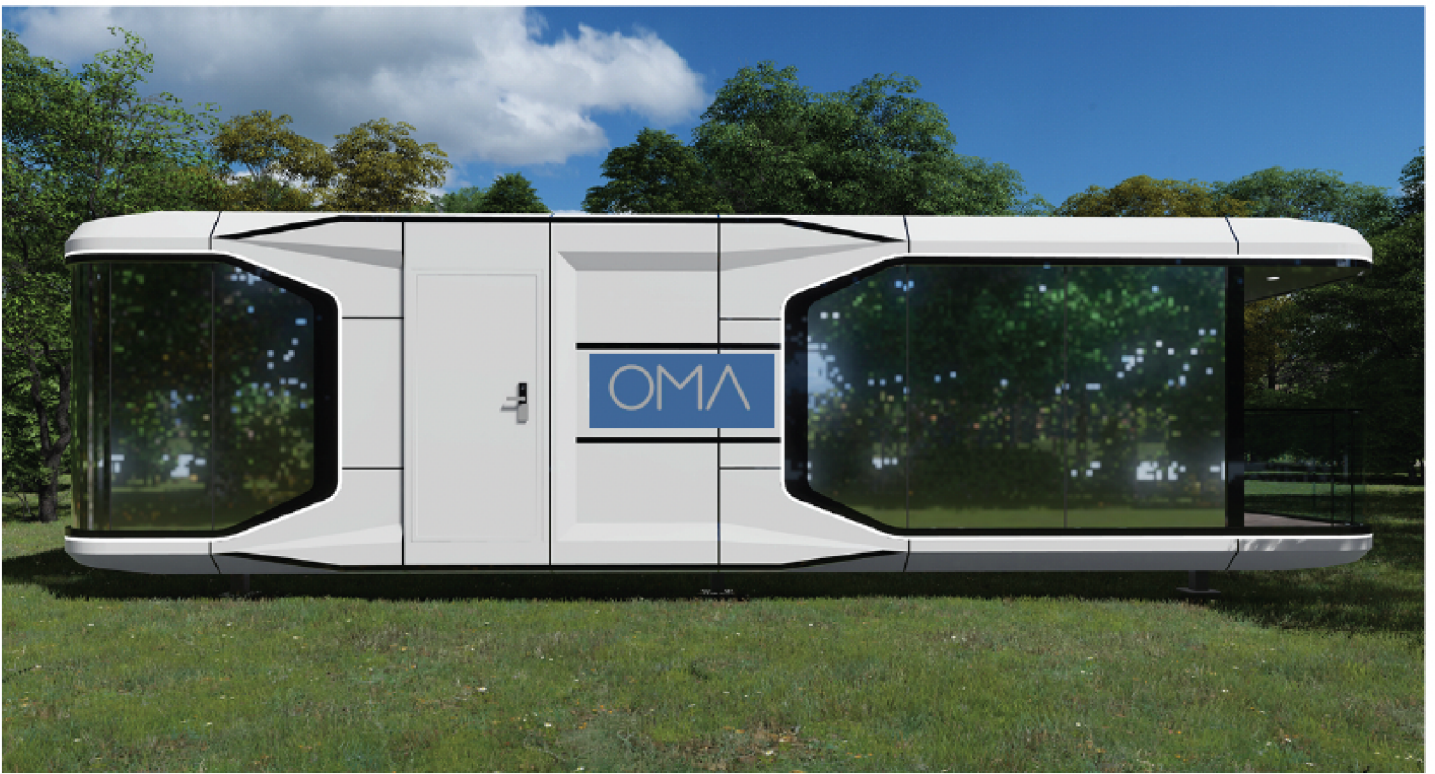

# CP7 Plug&Play Cabin



CP7S

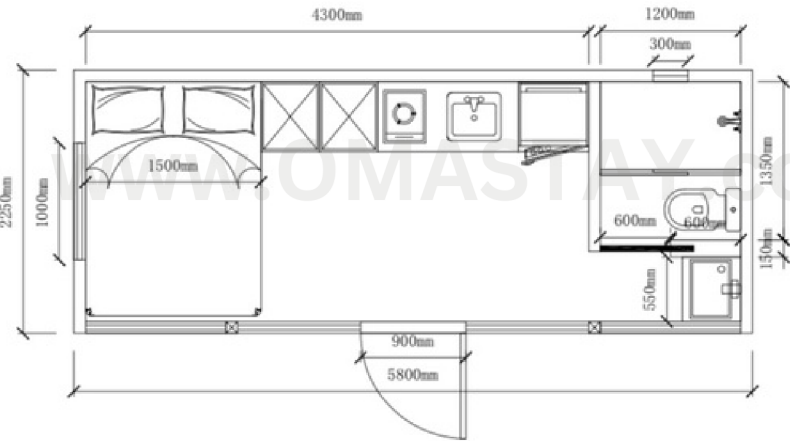

5800x2250x2450  
5800x2250 (terrace) \*OPTIONAL

- fits 2 per 40ft HC



## Fully Fitted Kitchenette

Hoob/Sink/Fridge /Counter

Convertible table

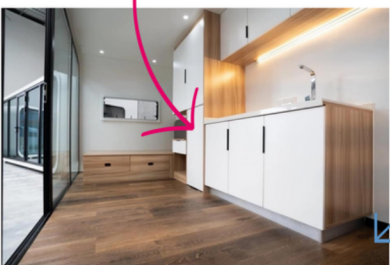

Full height Fridge



## Fully Fitted Bathroom

wet&dry separation + Ventilation  
Hot&Cold Shower, Vanity Cabinets & Sink, toilet bowl

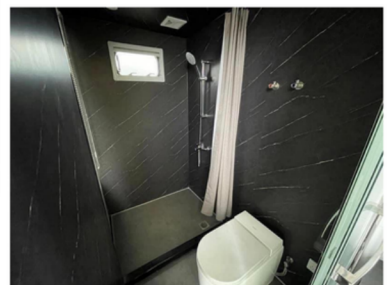

- Quality rust proof fittings
- Chrome Finishing
- Minimalist Modern Design



# CP7 Plug&Play Cabin



CP7S

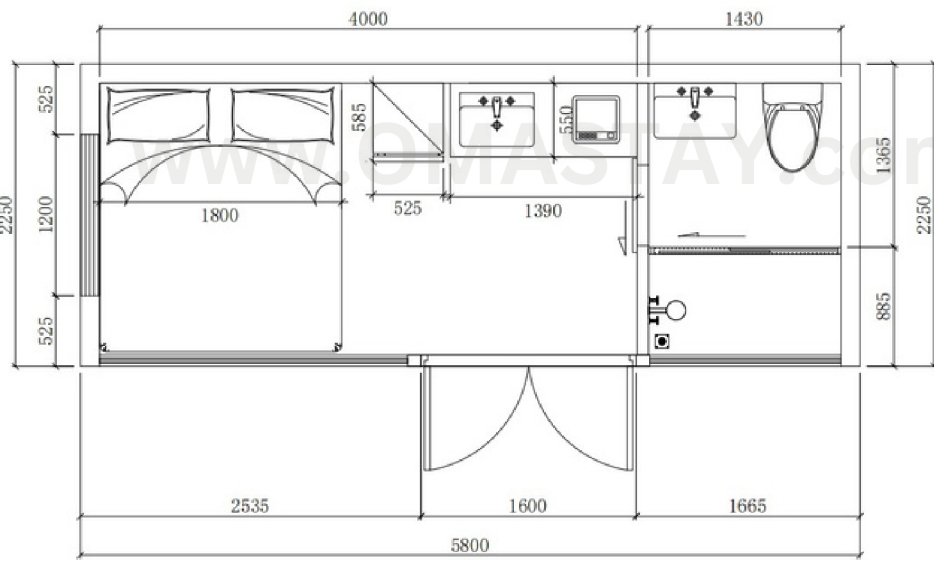

5800x2250x2450  
5800x2250 (terrace) \*OPTIONAL

- fits 2 per 40ft HC



1 YEAR WARRANTY



**Full Bathroom**  
wet & dry separation + ventilation  
Hot & Cold shower, vanity & sink, toilet bowl



Option to place  
full height fridge or mini fridge

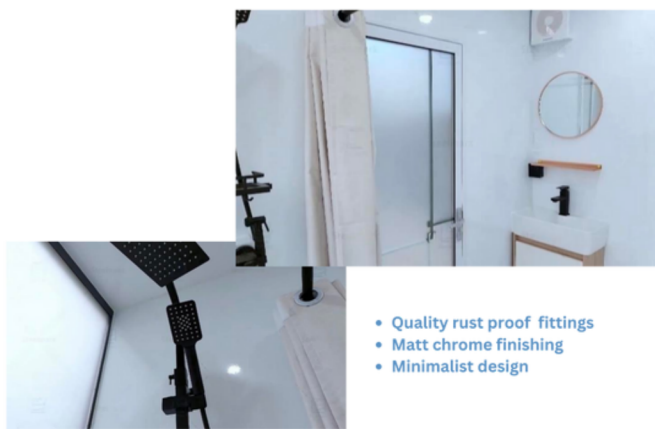

1 YEAR WARRANTY



1 YEAR WARRANTY



# CP7 Plug&Play Cabin



**CP7SDT**  
**complete**

2 Bedroom Duplex + Sofabed  
with Kitchen / Dining / Bathroom / Living + Sundeck



Easy on-site installation



Easy on-site installation



Option to have full glass both sides



temporary steel structure provided

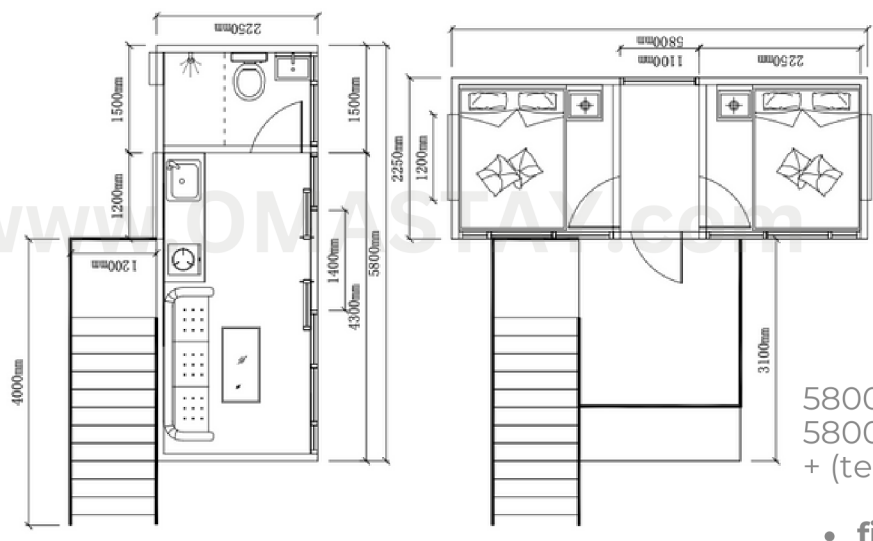

5800x2250x2450  
5800x2250x2450 (2nd Level)  
+ (terrace)

- fits 1 set per 40ft HC



# CP7 Plug&Play Cabin



**CP7M**  
complete

1 Spacious Bedroom  
with Kitchen / Dining / Bathroom

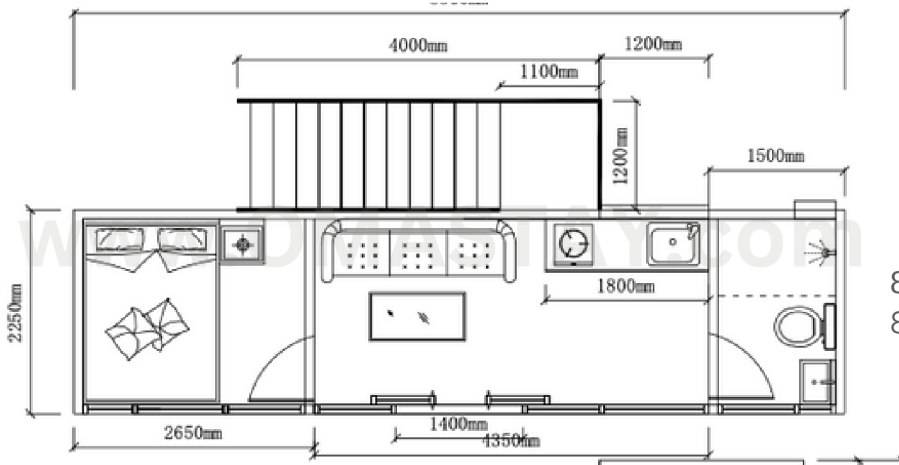

8500x2250x2450  
8500x2250 (terrace) \*optional

- fits 1 set per 40ft HC



# CP7 Plug&Play Cabin



**CP7M** 3 Bedrooms  
**complete** with Kitchen / Dining / Living & 2 Bathrooms

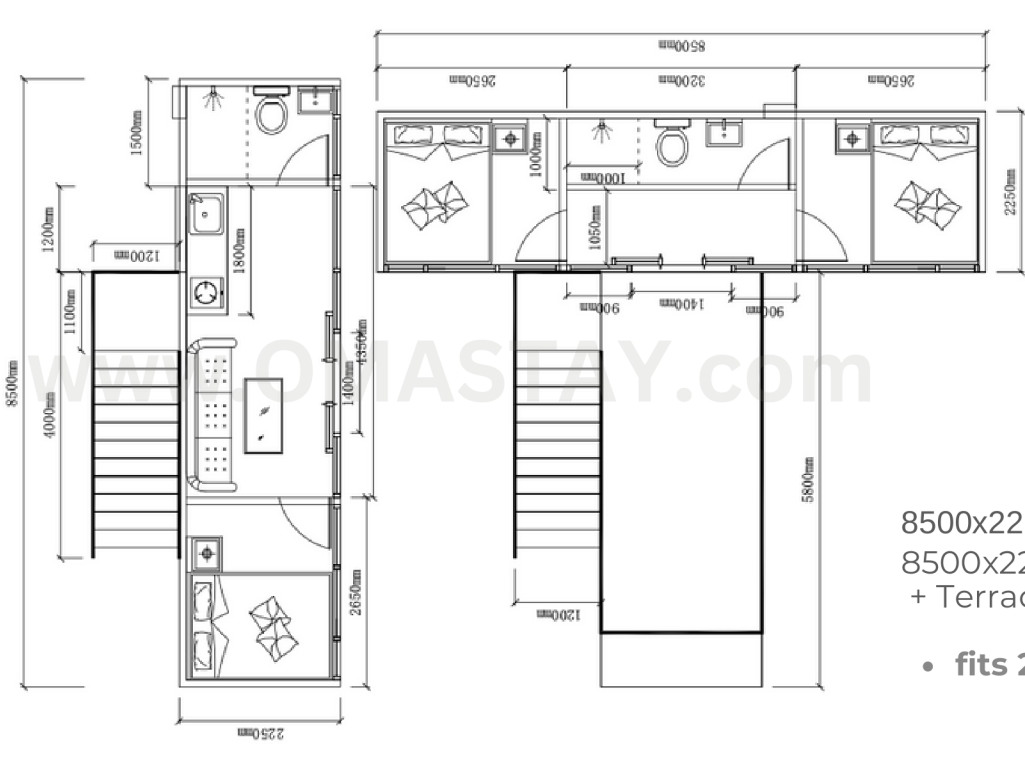

**OMA Global Pte Ltd**  
1 Scotts Road #24-05  
Singapore 228208  
dan@omastay.com

Mobile//Whatsapp +65 8284 6788



# CP7 Plug&Play Cabin



**CP7L**  
complete

2 Bedrooms  
with Kitchen / Dining / Living & Bathroom

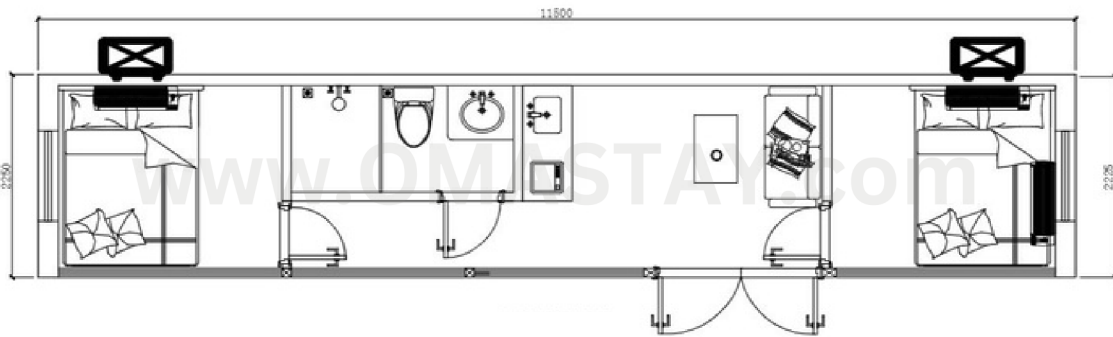

11500x2250x2450  
• fits 1 x 40ft HC

**CP7JD**

3 Bedrooms JUMBO DOUBLE STORY  
Kitchen / Dining / Living & 2 Bathrooms & Dual terrace

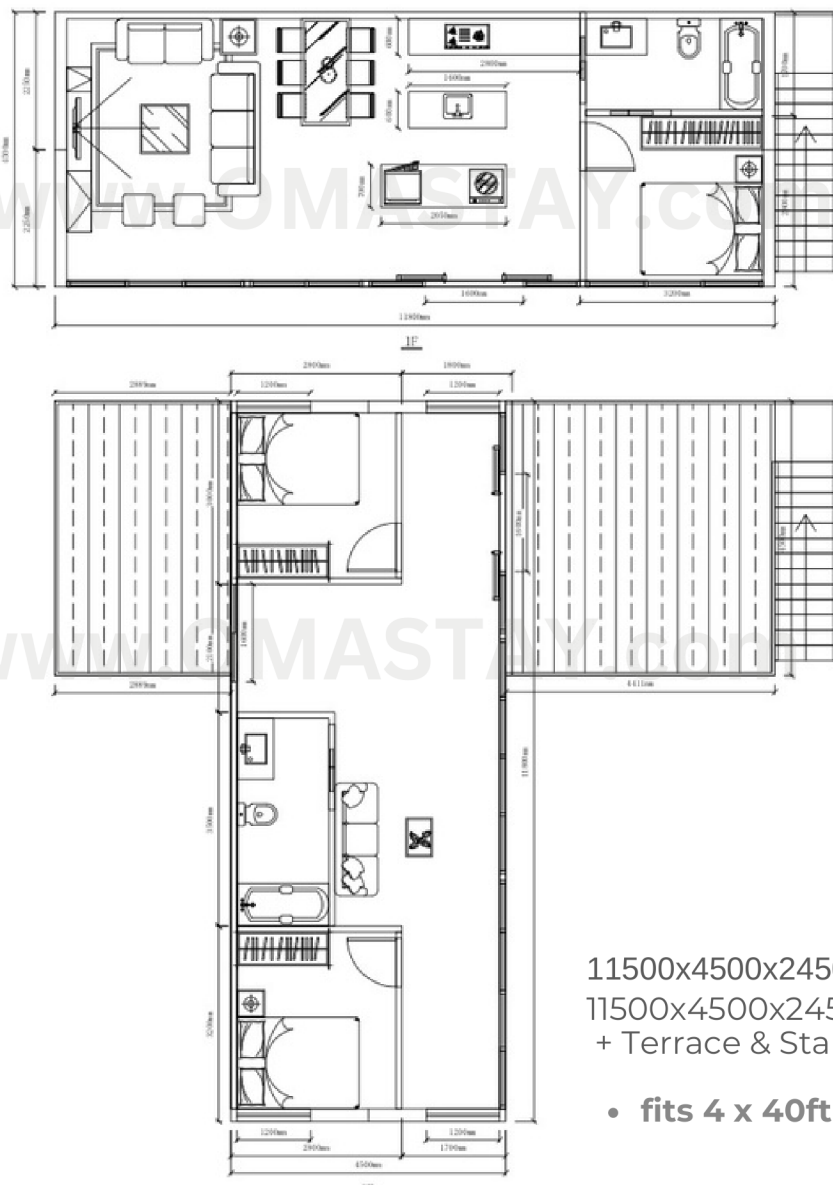

11500x4500x2450  
11500x4500x2450 (2nd level)  
+ Terrace & Stairs  
• fits 4 x 40ft HC

available in many colors and configurations



**we only use excellent quality interior and fittings**

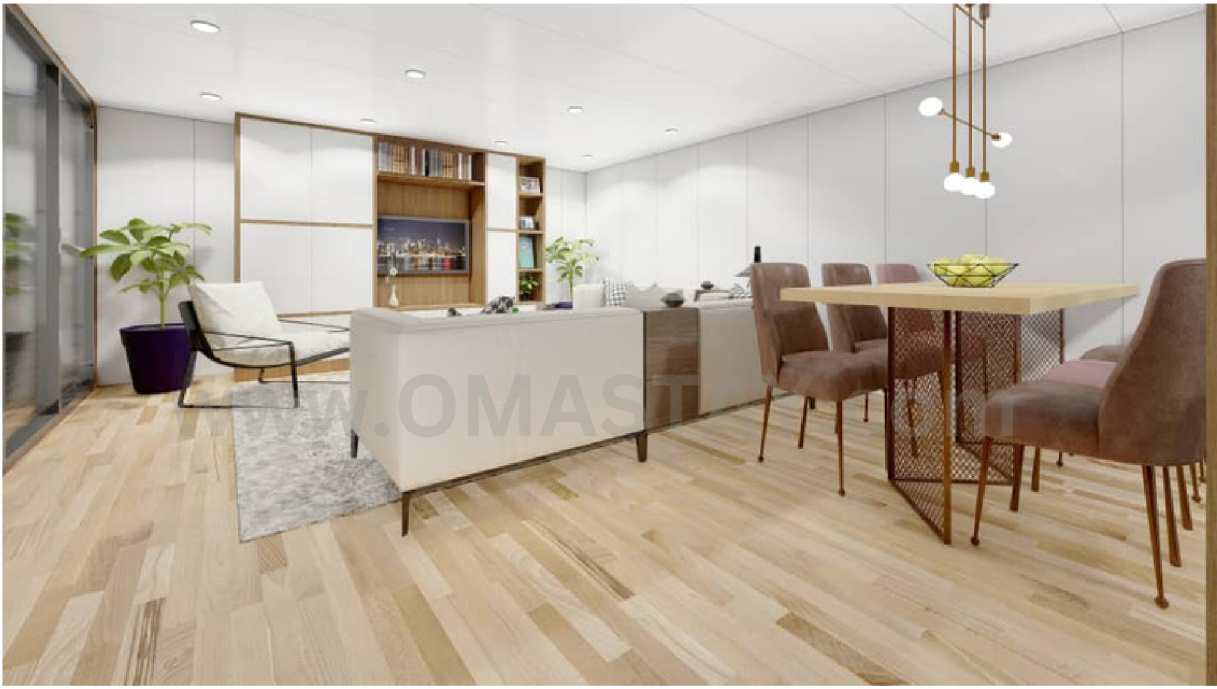

# Plug & Play



The CP7 cabins have been meticulously crafted with a focus on versatility, modularity, and global accessibility. Designed to meet diverse needs, these cabins boast a seamless blend of functionality and adaptability. With a myriad of configuration options available, the possibilities for mixing and matching different cabin sizes are virtually limitless. Furthermore, their streamlined design facilitates effortless global shipping, ensuring that they can be easily transported to destinations around the world.



**Plug & Play Easy Installation**  
for all pre fixed CP Cabins

Instruction Manual Included

## the Factory

The factory with which we collaborate brings to bear over three decades of expertise in the precision crafting of steel frame modular prefab housing, catering specifically to high-profile government projects on a global scale. Through our enduring partnership, we have cultivated exclusive lines, cutting-edge designs, and pioneering developments that set industry benchmarks. Additionally, our extensive network of factory alliances across the globe underscores our commitment to delivering unparalleled quality and service on a worldwide scale.

